

Motor Cable Identification

Direction 1	Brown
Direction 2	Black
Brake	Grey
Neutral	Blue
Earth	Yellow/Green

Black and Brown connection will vary according to system set-up.

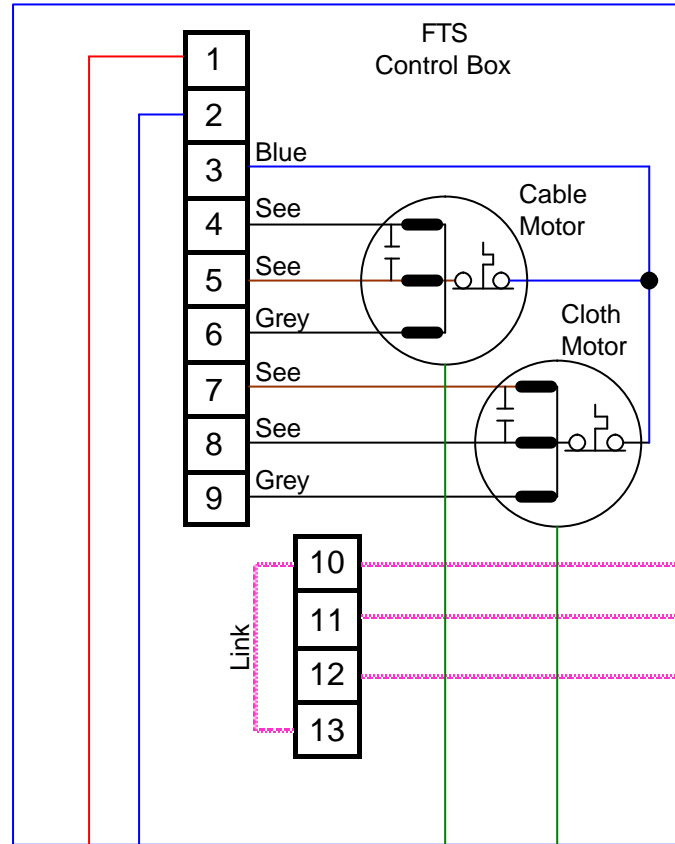
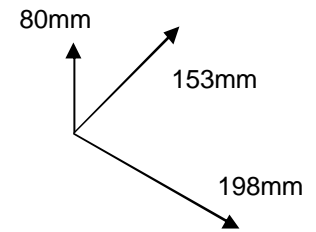

Only use switch provided

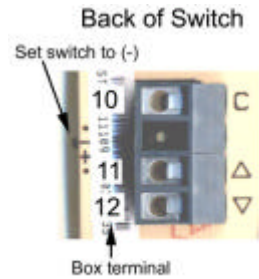
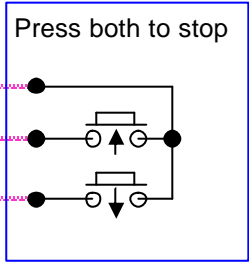

Never Connect more than One Blind into One Control Box

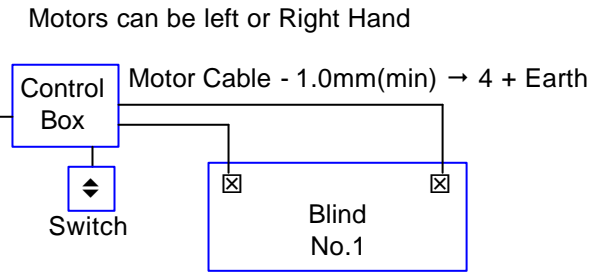

Tip:

- Always make sure the control box is accessible for setting up the blind and for future maintenance (fitting the control box so it is inaccessible when the blind is closed is not a good idea).

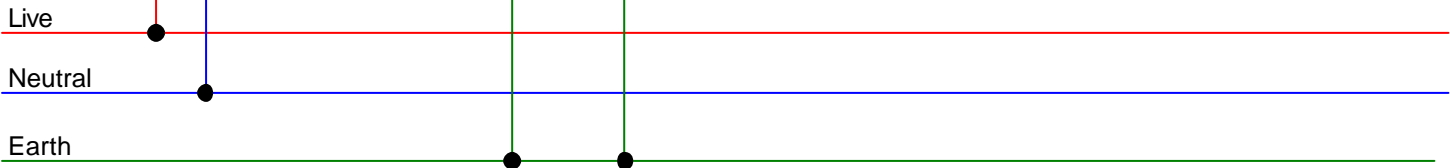

Low Voltage

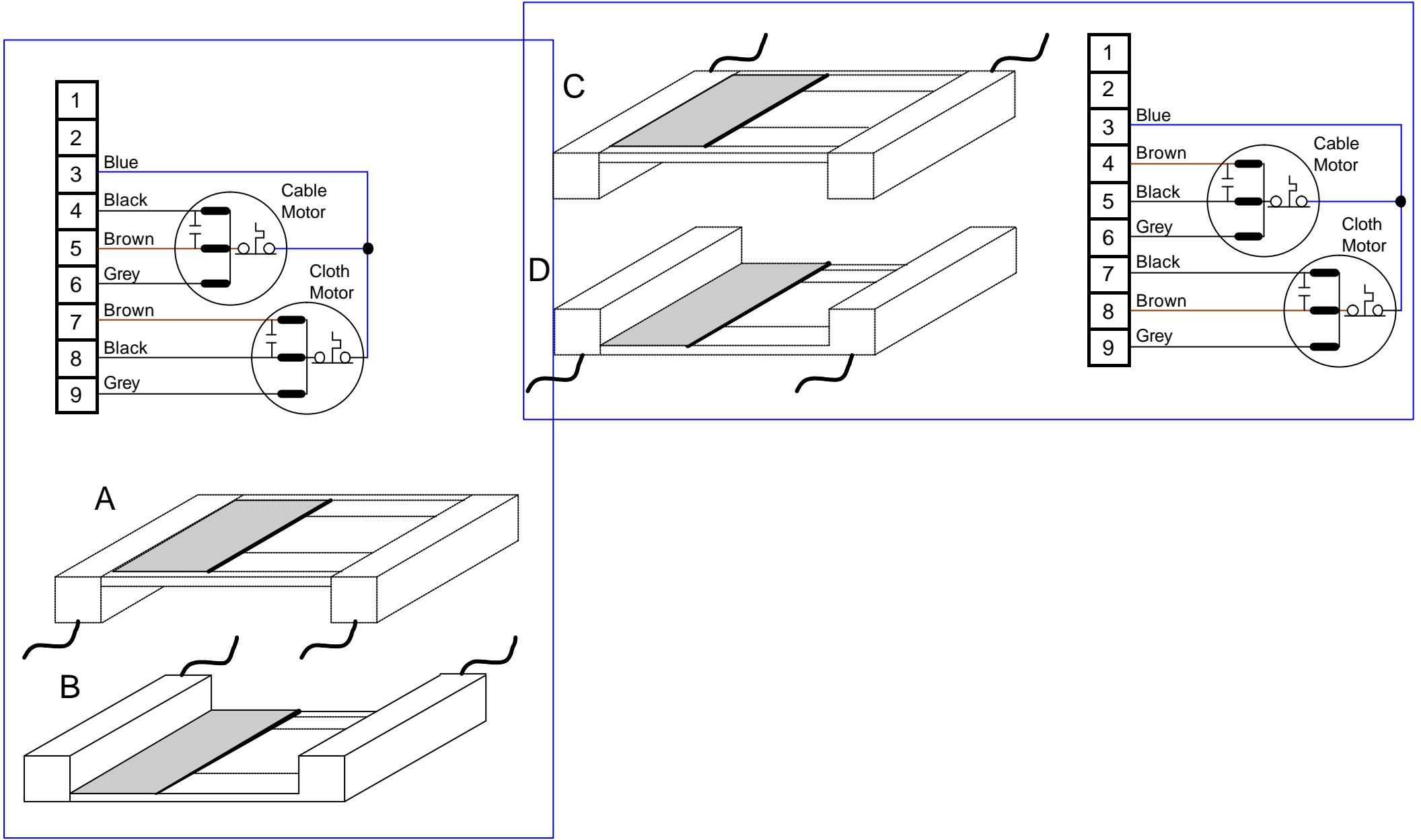

1 FTS to 1 wired in Switch - Issue 09/09
 Black and Brown identification & connection

